

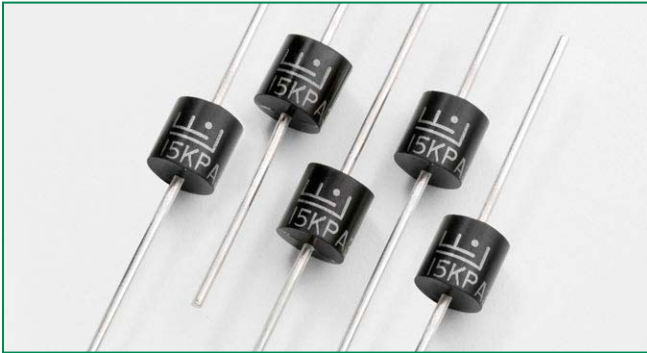

**RoHS 15KPA Series**

**Agency Approvals**

AGENCY	AGENCY FILE NUMBER
	E128662/E230531

**Maximum Ratings and Thermal Characteristics  
(T<sub>A</sub>=25°C unless otherwise noted)**

Parameter	Symbol	Value	Unit
Peak Pulse Power Dissipation by 10x1000µs test waveform (Fig.1) (Note 1)	P <sub>PPM</sub>	15000	W
Steady State Power Dissipation on infinite heat sink at T <sub>L</sub> =75°C (Fig. 5)	P <sub>D</sub>	8.0	W
Peak Forward Surge Current, 8.3ms Single Half Sine Wave Unidirectional only (Note 2)	I <sub>FSM</sub>	400	A
Operating Junction and Storage Temperature Range	T <sub>J</sub> , T <sub>STG</sub>	-55 to 175	°C
Typical Thermal Resistance Junction to Lead	R <sub>θJL</sub>	8.0	°C/W
Typical Thermal Resistance Junction to Ambient	R <sub>θJA</sub>	40	°C/W

**Notes:**

1. Non-repetitive current pulse, per Fig. 3 and derated above T<sub>A</sub> = 25°C per Fig. 2.
2. Measured on 8.3ms single half sine wave or equivalent square wave, duty cycle=4 per minute maximum.

**Description**

The 15KPA Series is designed specifically to protect sensitive electronic equipment from voltage transients induced by lightning and other transient voltage events.

**Features**

- RoHS compliant
- Typical maximum temperature coefficient  $\Delta V_{BR} = 0.1\% \times V_{BR} @ 25^\circ\text{C}$
- Glass passivated chip junction in P600 package
- 15000W peak pulse capability at 10x1000µs waveform, repetition rate (duty cycles):0.01%
- Fast response time: typically less than 1.0ps from 0 Volts to BV min
- Excellent clamping capability
- Low incremental surge resistance
- Typical I<sub>R</sub> less than 2µA above 36V
- High temperature soldering guaranteed: 260°C/40 seconds / 0.375" (9.5mm) lead length, 5 lbs., (2.3kg) tension
- Plastic package has Underwriters Laboratory Flammability classification 94V-0
- Matte Tin Lead-free plated

**Applications**

TVS devices are ideal for the protection of I/O interfaces, V<sub>CC</sub> bus and other vulnerable circuits used in telecom, computer, industrial and consumer electronic applications.

### Electrical Characteristics

Part Number (Uni)	Part Number (Bi)	Reverse Stand off Voltage $V_R$ (Volts)	Breakdown Voltage $V_{BR}$ (Volts) @ $I_T$	Test Current $I_T$ (mA)	Maximum Peak Pulse Current $I_{PP}$ (A)	Maximum Reverse Leakage $I_R$ @ $V_R$ ( $\mu$ A)	Maximum Clamping Voltage $V_C$ @ $I_{PP}$ (V)	Agency Approval 
			MIN					
15KPA17A	15KPA17CA	17	18.99	50	515.4	5000	29.3	X
15KPA18A	15KPA18CA	18	20.11	50	488.7	5000	30.9	X
15KPA20A	15KPA20CA	20	22.34	20	440.2	1500	34.3	X
15KPA22A	15KPA22CA	22	24.57	10	407.0	500	37.1	X
15KPA24A	15KPA24CA	24	26.81	5	371.0	150	40.7	X
15KPA26A	15KPA26CA	26	29.04	5	343.2	50	44.0	X
15KPA28A	15KPA28CA	28	31.28	5	317.9	25	47.5	X
15KPA30A	15KPA30CA	30	33.51	5	297.8	15	50.7	X
15KPA33A	15KPA33CA	33	36.90	5	276.1	2	54.7	X
15KPA36A	15KPA36CA	36	40.20	5	252.5	2	59.8	X
15KPA40A	15KPA40CA	40	44.70	5	229.5	2	65.8	X
15KPA43A	15KPA43CA	43	48.00	5	216.3	2	69.8	X
15KPA45A	15KPA45CA	45	50.30	5	207.4	2	72.8	X
15KPA48A	15KPA48CA	48	53.60	5	194.3	2	77.7	X
15KPA51A	15KPA51CA	51	57.00	5	182.1	2	82.9	X
15KPA54A	15KPA54CA	54	60.30	5	172.2	2	87.7	X
15KPA58A	15KPA58CA	58	64.80	5	161.0	2	93.8	X
15KPA60A	15KPA60CA	60	67.00	5	155.0	2	97.4	X
15KPA64A	15KPA64CA	64	71.50	5	144.9	2	104.2	X
15KPA70A	15KPA70CA	70	78.20	5	132.9	2	113.6	X
15KPA75A	15KPA75CA	75	83.80	5	123.8	2	122.0	X
15KPA78A	15KPA78CA	78	87.10	5	119.7	2	126.1	X
15KPA85A	15KPA85CA	85	94.90	5	109.7	2	137.6	X
15KPA90A	15KPA90CA	90	100.50	5	103.7	2	145.6	X
15KPA100A	15KPA100CA	100	111.70	5	93.6	2	161.3	X
15KPA110A	15KPA110CA	110	122.90	5	84.5	2	178.6	X
15KPA120A	15KPA120CA	120	134.00	5	78.5	2	192.3	X
15KPA130A	15KPA130CA	130	145.20	5	72.5	2	208.3	X
15KPA150A	15KPA150CA	150	167.60	5	62.4	2	241.9	X
15KPA160A	15KPA160CA	160	178.70	5	58.4	2	258.6	X
15KPA170A	15KPA170CA	170	189.90	5	55.4	2	272.7	X
15KPA180A	15KPA180CA	180	201.10	5	52.3	2	288.5	X
15KPA200A	15KPA200CA	200	223.40	5	47.3	2	319.1	X
15KPA220A	15KPA220CA	220	245.70	5	35.2	2	428.6	X
15KPA240A	15KPA240CA	240	268.10	5	39.3	2	384.6	X
15KPA260A	15KPA260CA	260	290.40	5	36.2	2	416.7	X
15KPA280A	15KPA280CA	280	312.80	5	33.2	2	454.5	X

For bidirectional type having  $V_R$  of 30 volts and less, the  $I_R$  limit is double.

For parts without A, the  $V_{BR}$  is  $\pm 10\%$  and  $V_C$  is 5% higher than with A parts

## Ratings and Characteristic Curves ( $T_A=25^\circ\text{C}$ unless otherwise noted)

### Figure 1 - Peak Pulse Power Rating Curve

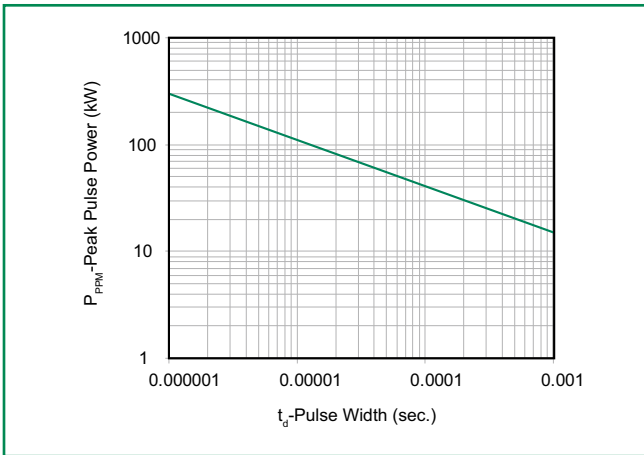

### Figure 2 - Pulse Derating Curve

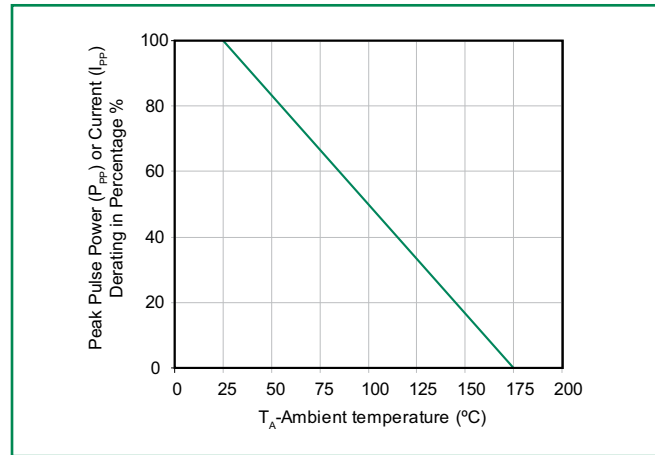

### Figure 3 - Test Pulse Waveform

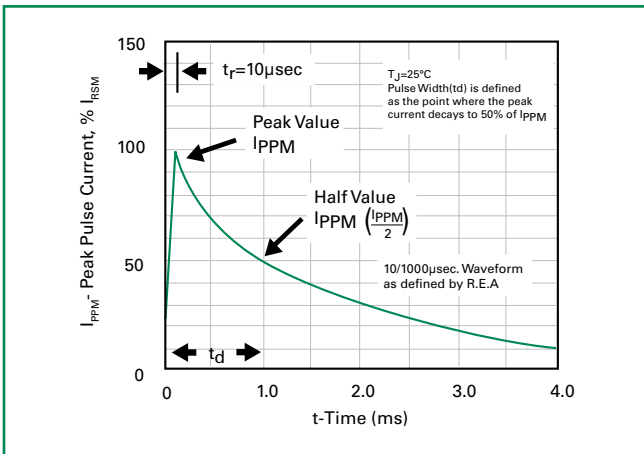

### Figure 4 - Typical Junction Capacitance

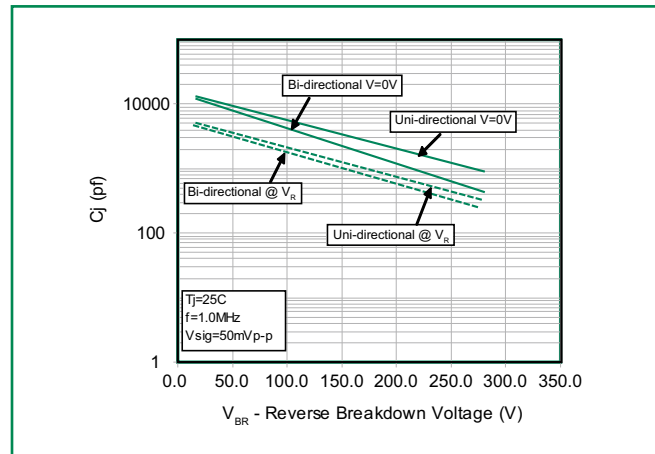

### Figure 5 - Steady State Power Derating Curve

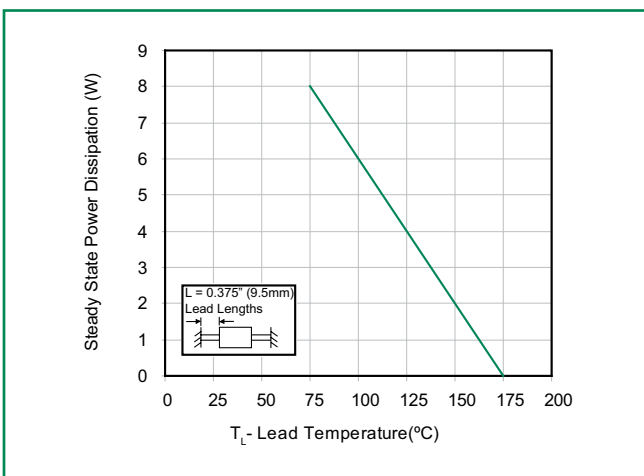

### Figure 6 - Maximum Non-Repetitive Forward Surge Current

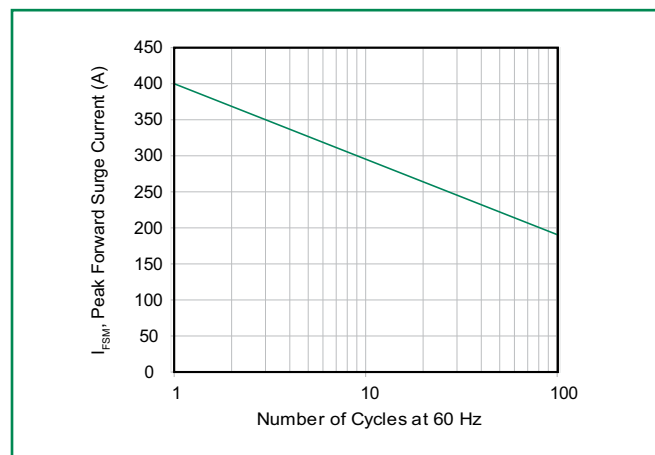

### Soldering Parameters

Reflow Condition		Lead-free assembly
Pre Heat	- Temperature Min ( $T_{s(min)}$ )	150°C
	- Temperature Max ( $T_{s(max)}$ )	200°C
	- Time (min to max) ( $t_s$ )	60 – 180 secs
Average ramp up rate (Liquidus Temp ( $T_L$ ) to peak)		3°C/second max
$T_{s(max)}$ to $T_L$ - Ramp-up Rate		3°C/second max
Reflow	- Temperature ( $T_L$ ) (Liquidus)	217°C
	- Time (min to max) ( $t_s$ )	60 – 150 seconds
Peak Temperature ( $T_p$ )		260 <sup>+0/-5</sup> °C
Time within 5°C of actual peak Temperature ( $t_p$ )		20 – 40 seconds
Ramp-down Rate		6°C/second max
Time 25°C to peak Temperature ( $T_p$ )		8 minutes Max.
Do not exceed		280°C

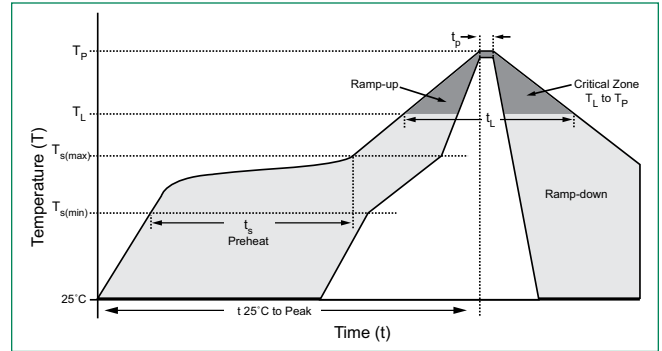

### Flow/Wave Soldering (Solder Dipping)

<b>Peak Temperature :</b>	265°C
<b>Dipping Time :</b>	10 seconds
<b>Soldering :</b>	1 time

### Physical Specifications

<b>Weight</b>	0.07oz., 2.5g
<b>Case</b>	P600 molded plastic body over passivated junction.
<b>Polarity</b>	Color band denotes the cathode except Bipolar.
<b>Terminal</b>	Matte Tin axial leads, solderable per JESD22-B102D.

### Environmental Specifications

<b>Temperature Cycle</b>	JESD22-A104
<b>Pressure Cooker</b>	JESD 22-A102
<b>High Temp. Storage</b>	JESD22-A103
<b>HTRB</b>	JESD22-A108
<b>Thermal Shock</b>	JESD22-A106

### Dimensions

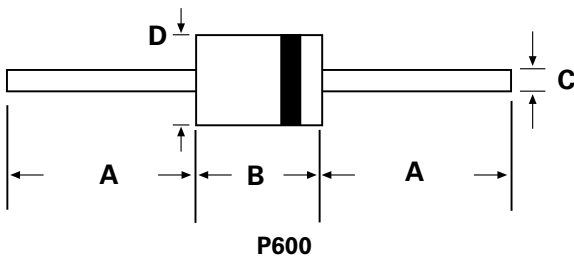

Dimensions	Inches		Millimeters	
	Min	Max	Min	Max
A	1.000	-	25.40	-
B	0.340	0.360	8.60	9.10
C	0.048	0.052	1.22	1.32
D	0.340	0.360	8.60	9.10

## Part Numbering System

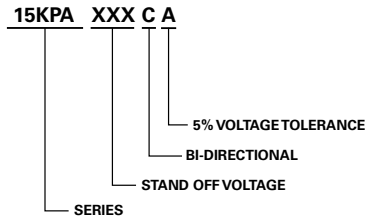

Option: Suffix B is for bulk packing.

## Part Marking System

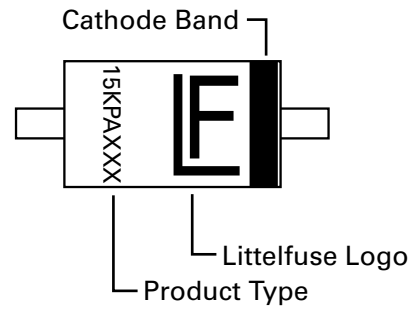

## Packaging

Part Number	Component Package	Quantity	Packaging Option	Packaging Specification
15KPAxxxXX	P600	800	Tape & Reel	EIA STD RS-296E
15KPAxxxXXB	P600	500	BOX	Littelfuse Concord Packing Spec. DM-0016